



We are technology,  
profitability, and  
environment.



## We are technology, profitability, and environment

Thank you for taking the time to look through our catalogue.

This catalogue is the result of more than 55 years dedicated to materials and equipment for livestock farming since our founder, coming from the stockbreeding world and motivated by the needs of the sector, began to manufacture the first products.

Since 2004, the company has been dedicated exclusively to the manufacture of products related to slurry from the inside of the farm to the outside, with the most sophisticated treatment systems for the revaluation or purification of slurry.

We hope that here you will find the product that best meets your needs. Segalés offers a combination of experience and research with the most advanced technologies, always taking into account quality, economy, and the human factor.

Our goal is to improve the environment so that we can leave a better world for future generations and, at the same time, ensure that your livestock enterprises remain as profitable as possible.

Now, the second generation has joined the company. This development has led to an important technological leap forward and allows us to offer a series of completely innovative products that will change the concept of the farm and the public's perception of it.

We want to transmit this change through a new image and two colour lines: one for the machinery, maintaining our corporate orange colour, and another in green for environmental treatments and improvements.

We want to meet your needs and improve your business.

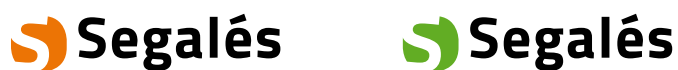

*Specialists in the separation, handling, and treatment of slurry.*



**Miquel Segalés, Marta Segalés i Toni Vila.**  
Managers of the company together with Miquel Segalés, one of the founders.



# Index

Advantages of slurry separation .....	04
Slurry and digestate separators .....	05
Technical features .....	06
Supporting platforms .....	08
Kompact® equipment: Ramp and separator .....	09
Mobile separation plants .....	10
Separators for injecting liquid for drip irrigation .....	11
Slurry treatment plants .....	12
Acidification systems .....	14
Slurry evaporation tunnel .....	15
Nutrient concentration in the solid fraction .....	16
Flotation plants.....	17
AGV Sucker® .....	18
Biogas .....	20
Airesa slurry trays .....	21
Slurry for cow bedding .....	22
Bedding and Bedding Rack .....	24
Submersible grinder pumps .....	25
Indoor homogenization .....	26
Mobile long reach mixers for indoor/outdoor pits .....	27
Hydraulic mixers .....	28
Agitation .....	29
Fixing systems for stirrers .....	30
Slurry loading and volume and nitrogen controls .....	31
Liquid filtration / initial roughing and static ramps .....	32
Liquid filtration / fine screening .....	33
Control types .....	34
Accessories .....	35

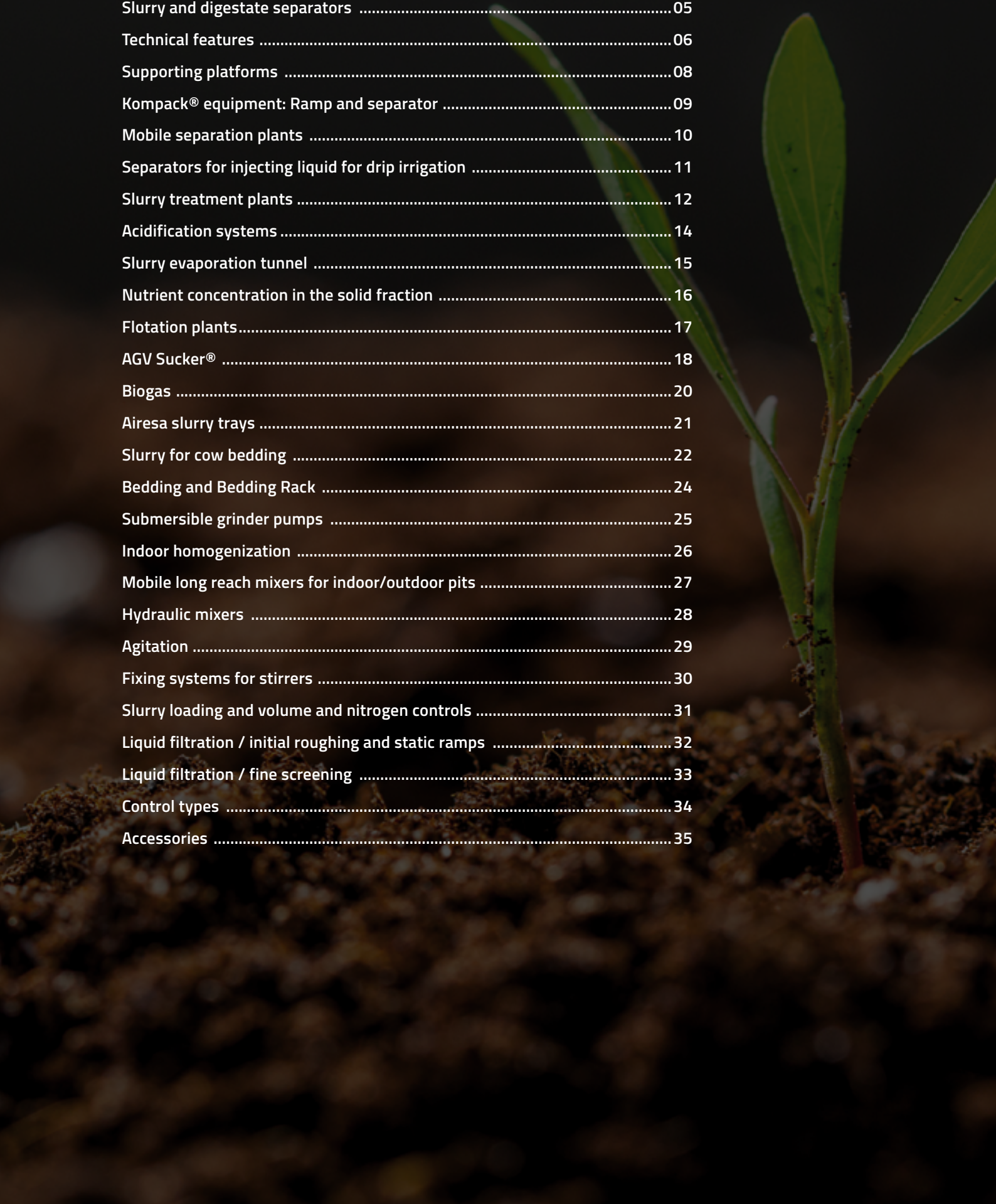

# Benefits of slurry separation



## STAGE 1

It is the first step for most nitrogen scrubbing or nitrogen reduction treatment systems.

The slurry, once separated, does not smell. Volume reduction.

The resulting liquid can be used for irrigation, including drip irrigation (mixed with water).

The liquid fraction leaves practically no deposits or solids in the basin, preventing the accumulation of solids in it.

It is easy and quick to load with the tank.

From the first to the last tanker, the composition of the liquid remains practically unchanged.

The solid fraction is easy to store and handle.

Up to 30-35% dry matter can be obtained in the solid fraction.

The solid fraction is easily recoverable.

Thanks to the possibility of varying the moisture content, an ideal product for composting can be obtained.

## Pig plant study | MOTHERS AND FATTENING

Comparative study of the input slurry and the different fractions (solids and liquids) extracted from a slurry separator. These are some examples, although we are aware that each farm will be different.

PARAMETERS		MOTHER'S SLURRY ANALYSIS SAMPLES UP TO 20 KG.			
		Liquid fraction double filtration	Solid fraction first filtration	Solid fraction double filtration	Slurry
pH	u.pH	7,85	8,62	8,59	7,15
Density	kg/l	1,002	0,240	0,96	1,00
C. electrical diluted 1:9	µS/cm	1158	-	-	1493
C. electrical	mS/cm	9,01	-	-	11,06
C. electrical in solids	µS/cm	-	777	1197	-
Humidity	%	98,94	73,11	81,84	98,57
Volatile solids	%	99,70	98,20	93,65	99,56
Total solids	%	1,06	26,89	18,16	1,43
Ammoniacal nitrogen	kg/m <sup>3</sup> N amoniacal	1,03	0,27	2,23	1,32
Total nitrogen	kg/m <sup>3</sup> N total	1,81	1,31	6,03	2,82
Phosphorus (P <sub>2</sub> O <sub>5</sub> )	kg/m <sup>3</sup> P <sub>2</sub> O <sub>5</sub>	0,38	0,28	0,92	0,46
Potassium (K <sub>2</sub> O)	Potasio (K <sub>2</sub> O) kg/m <sup>3</sup> K <sub>2</sub> O	0,71	0,23	0,98	1,03
COD	mg/l O <sub>2</sub>	16.368,00	4.982,51	21.844,04	21.324,00
N-NO <sub>2</sub>	mg/l	3,85	2,10	10,24	5,77
N-NO <sub>3</sub>	mg/l	19,44	8,24	43,52	26,32

PARAMETERS		SLURRY ANALYSIS SAMPLES FATTENING				
		Liquid fraction 1	Solid fraction 1	Liquid fraction 2	Solid fraction 2	Slurry
pH	u.pH	8,06	8,89	8,35	8,49	7,97
EC	dS/m	26,9	2,44	26,2	4,39	25,6
ST	g/kg	30,8	253,5	30,1	149,7	33,2
SV	g/kg	18,2	228,4	17,4	116,6	20,5
Total N Kjedadahl	g/kg	5,11	8	5,04	7,6	5,34
Ammoniacal N	g/kg	3,87	3,1	3,91	3,9	3,98

## BEEF PLANT STUDY

PARAMETERS		ANALYSIS SAMPLES CATTLE SLURRY				
		Liquid fraction 1	Solid fraction 1	Liquid fraction 2	Solid fraction 2	Slurry
pH	u.pH	7,32	8,84	7,49	8,07	7,42
EC	dS/m	17,25	1,379	17	2,25	15,76
ST	g/kg	41,5	206,4	38,1	89,5	72,3
SV	g/kg	31,2	192,1	28,1	78	61,5
Total N Kjedadahl	g/kg	4,44	3,4	4,32	3,1	4,42
Ammoniacal N	g/kg	2,78	0,4	2,79	1,1	2,76



# Slurry and digestate separators

## SOLID/LIQUID SEPARATOR

Designed to achieve the maximum utilisation of the two fractions once separated

Equipment with a separation range of between 6 m<sup>3</sup>/h and 80 m<sup>3</sup>/h

### SOLID FRACTION

Possibility of pressing regulation. It is possible to obtain from 20% to 35% of dry matt.

### LIQUID FRACTION

Depending on its destination, different sieve sizes from 250 microns to 1 mm can be used.

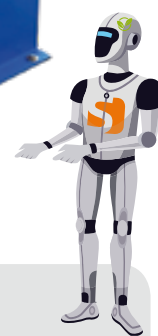

## MS 100

### MS100

4 kW  
6 - 30 m<sup>3</sup>/h



## MS 250

### MS250

5,5 kW  
10 - 40 m<sup>3</sup>/h



### Which separator separates the most?

Definitely, the one with the smallest sieve hole size.

### Will all farms separate the same amount of slurry?

Separation is influenced by different factors such as the age of the slurry, the production cycle, the feed, etc. This is why the % of concentration will vary on each farm. The sieves of our equipment can be up to 250 microns.

## MS 300

### MS300

7,5 kW  
15 - 60 m<sup>3</sup>/h



## MS 250 XL

### MS 250 X

5,5 kW  
25 - 80 m<sup>3</sup>/h

Designed to work with flocculant.



## MS 250 BG

5,5 kW

### MS BG - 250

Designed for direct loading without pump.



# Technical characteristics

## STANDARD OR SUPER-REINFORCED TRIANGULAR MESH SIEVES AISI 316 QUALITY

Standard or reinforced triangular mesh sieves Aisi 316 quality, preventing solid particles from clogging the sieve.

Possibility 0.25 - 0.5 - 0.75mm

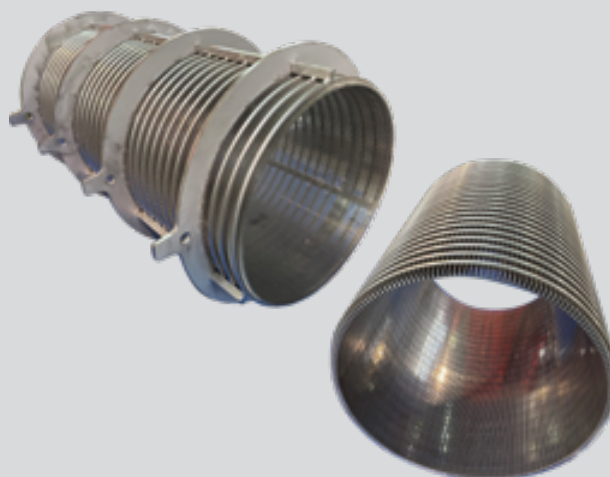
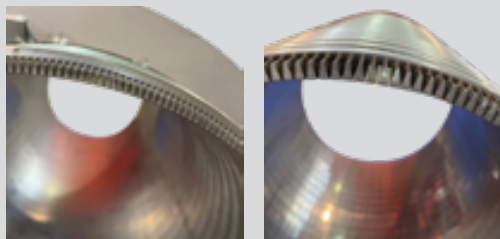

## MODULAR COUNTERWEIGHT

**Modular counterweight** that allows a better regulation of pressing.

From 2.5 kg to multiple modules of 10 kg to obtain more dry matter.



Possibility of introducing slurry from the top or bottom to maximize performance depending on the equipment.

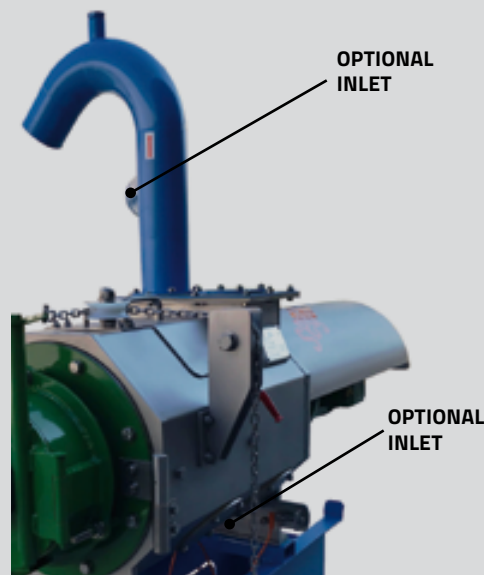

**Solid plug signal detector.** Stops pump and separator operation in case of no compaction.



## ADJUSTABLE COLLAR TO INCREASE DRY MATTER

**Adjustable neck.** In the event of a change in the % of solid matter in the slurry, it allows us to adapt it to ensure maximum performance



## HINGED FRONT NECK

**The hinged front neck** allows the manipulation of thread and sieve, facilitating the maintenance functions of the equipment.

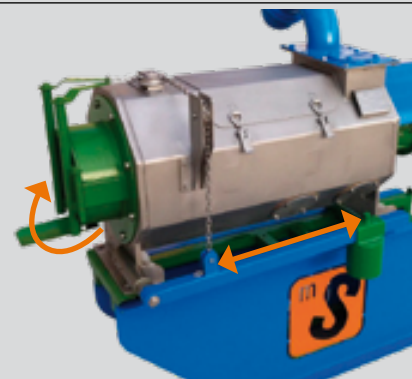

## PRESSING GATES WITH COUNTERWEIGHTS

**Pressing gates with counterweights** that regulate the percentage of dry matter at all times.

**Body made entirely of stainless steel.**  
Ideal for working with slurry.

**Labyrinth device that prevents the entry of liquid into the reducer,** facilitating the sealing between the thread and thus avoiding its deterioration.

**Large hatch.** Facilitates internal inspection of the sieve.

**TUNGSTEN CARBIDE COATED SPIRAL WITH A HARDNESS OF HARDNESS 2.500 HV0,2**

**Stainless steel spiral,** higher wear resistance, and longer thread life without changing the working characteristics.

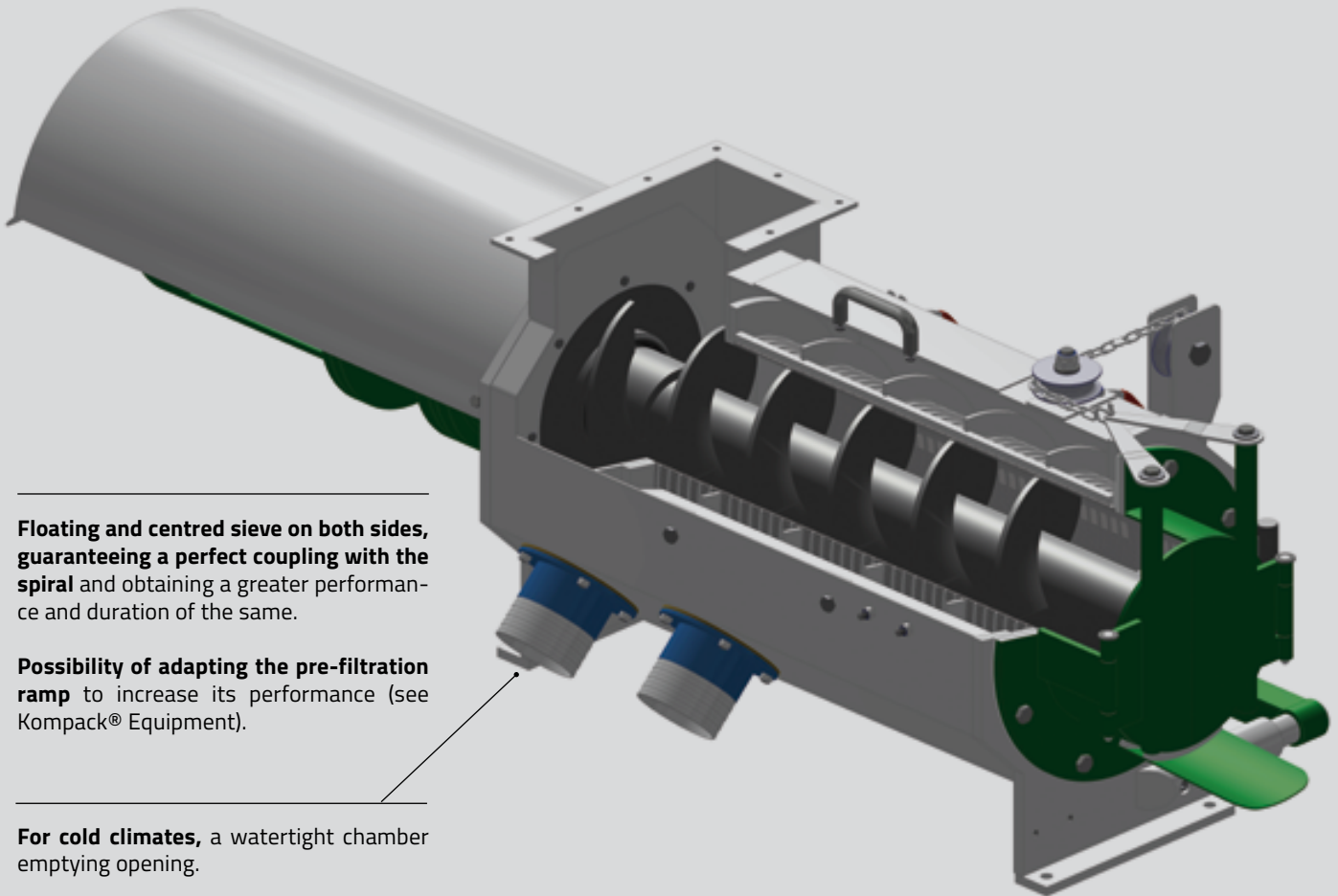
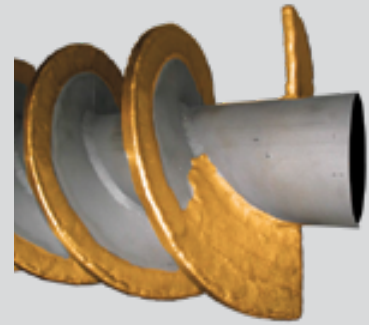

**Floating and centred sieve on both sides, guaranteeing a perfect coupling with the spiral** and obtaining a greater performance and duration of the same.

**Possibility of adapting the pre-filtration ramp** to increase its performance (see Kompack® Equipment).

**For cold climates,** a watertight chamber emptying opening.

In climatic zones where freezing is possible, this gate allows us to empty the chamber and avoid blockages caused by ice.

**BUFFER TANK 100 L**

For non-return operation, includes variable speed drive for the pump.

**STORAGE TANK ON SEPARATOR**

1 m<sup>3</sup> for non-return operation with siren.

**SEPARATOR VENT**

To avoid vacuum inside the sieve and maximize separator performance.





# Support platforms

Different platform models depending on the location of the separator

- Made of hot-dip galvanised steel.
- Modular and expandable.
- Protected with safety handrails.
- Access via cat ladder or normal ladder.
- Non-slip Tramex grating floor.
- Designed for easy placement of liquid and electrical piping.
- Option of support with legs or on wall.



**MODULAR PLATFORM** adapted for splitting equipment compatible with:  
**MS-100 / MS-250 / MS-300**

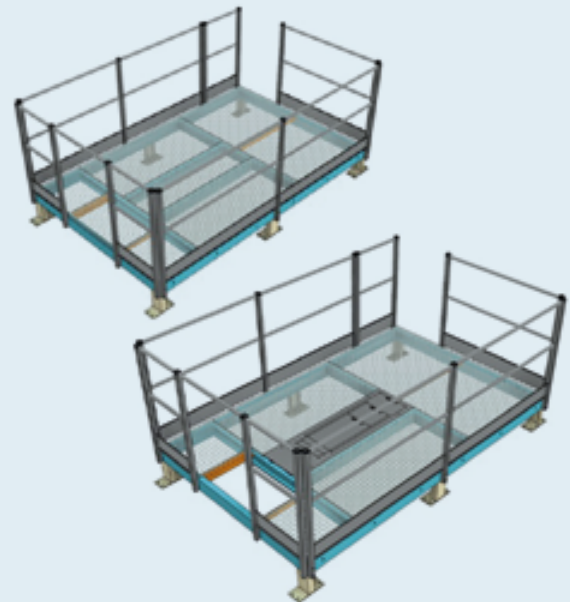

## 2 MODULAR PLATFORMS

joined and adapted, one for microfiltration equipment, the other for a separator.

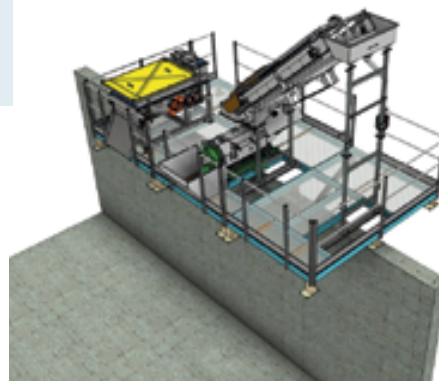
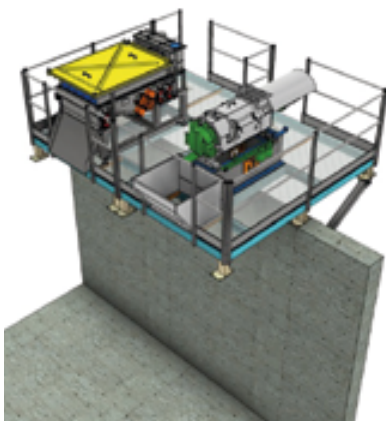

## 3 MODULAR PLATFORMS

joined and adapted, one for microfiltration equipment and the other for a K1.

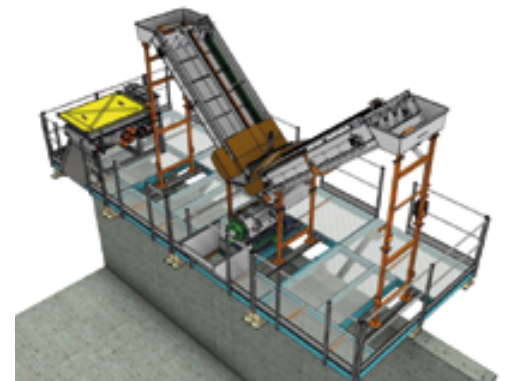

**4 MODULAR PLATFORMS** joined and adapted, one for microfiltration equipment and the other three for a K2.

# Kompack® Equipment: Ramp and Separator

Increase separation performance with **KOMPACK®** models.

Before deciding what equipment we need, it is essential to bear in mind the product to be separated, and that is why at Mecaniques Segalés we have designed specific equipment for pigs and cattle\*.

Bearing in mind that pig slurry in fattening does not exceed 5% solids and in mothers 3%, it allows us to make a first roughing in the pre-filtering ramp with which up to 60% of the liquid can be removed without energy costs or wear of the separator; **this represents a reduction in the cost of separation of 60%.**

The Kompack® equipment we have designed, whether for pig slurry or cattle slurry\*, allows these savings in separation costs. In addition, as they are fed by a much more homogeneous mixture coming from the chute, they favor the proper functioning of the separator.

To find out which equipment is best suited to your farm, we have the ECOPUR program, which will indicate not only the most suitable equipment, but also the consumption, amortization, and performance.

\*(Cleaning with water)

Request a performance study for your process.



## Kompack® 1

MS100 o MS250 + ramp 4,25 kW o 5,75kW



### Where do we put Kompack equipment?

*In farms for slurry with less than 8% solids, this way we will be able to separate up to 60% more slurry with practically no energy consumption.*

*Another advantage of this ramp is that, since it has no pressure, the liquid will come out cleaner.*

## Kompack® 050

MS 050 + ramp 2,75 kW



## Kompack® 2

MS 250 o MS300 + 2 ramps  
6 kW o 8 kW



## Kompack® 4

MS 300 + 4 ramps  
8,5 kW



**Ramp option from 280 microns upwards**

Kompack® 1: **8-60 m³/h** · Kompack® 2: **13-100 m³/h** · Kompack® 4: **23-200 m³/h**  
Kompack® 1/050: **5-35 m³/h**





## Mobile separation plants



- Designed according to the needs and volume to be treated.
- To be coupled to a tractor platform, tractor trailer, etc., TR-KOM models.
- BLOCK models with palletisable base.
- They can incorporate an electric generator.
- With vibrating sieve equipment if you wish to use the liquid for drip irrigation.
- They incorporate volumetric counters.
- Hose connections with quick couplings.
- High and mobile discharge auger for easy storage of solids.
- Can incorporate nitrification pump or stirrer.
- Incorporate feed pump.
- Electrical panel for the control of all the elements.

### To whom does a mobile plant appeal?

*For pig and dairy cattle associations, and / or owners of more than one farm, to go to separate several farms.  
The same team can separate more than 20 farms.*

**TR-KOM 2/250**



**TR-KOM 4/300 with microfiltering**





# Separators for liquid injection to dripper irrigation

## Separation and microfiltration equipment

Specially designed for drip fertigation with the liquid fraction of the slurry.

**80 to 90% of the slurry from a pig or cow farm is water, which makes this solution very cost-effective.**

### Maximum agronomic use of the nutrients in the slurry.

- The fertigation system allows us to apply the liquid fraction of the slurry at the most appropriate time depending on the plantation.
- We avoid being able to do this only at specific times of the year. So, as long as the crop demands nitrogen, we can supply it.
- We have no problems entering the fields with the tanks for fear of getting trapped.
- It is very economical, because if we have the fields close to the farm, the cost of delivery disappears.
- We set up central reception and storage facilities on the irrigation plots so that getting the liquid to the site is very economical.

This equipment has been the result of the Life Arimeda project ([www.lifearimeda.eu](http://www.lifearimeda.eu)) with which we set ourselves the objective of being able to fertigate without generating emissions.

Our part of the project consisted of obtaining a liquid product with the maximum amount of nutrients and as clean as possible to be injected into a drip irrigation system, in this case underground.

With this equipment we demonstrated, after three years of irrigation, that with the liquid fraction of slurry after the process we could take advantage of all the nutrients, giving them an agronomic value.



**This equipment has been in operation for 4 years in the LifeArimeda Project.**

**More information: [www.lifearimeda.eu](http://www.lifearimeda.eu)**

*(Example from a different farm)*

PARAMETERS		EXAMPLE TABLE ON A MOTHER FARM				
		Liquid fraction 1 Kompack 1	Solid fraction 1 Kompack 1	Liquid fraction 2 Vibrante SV1200	Solid fraction 2 Vibrante SV1200	Slurry
pH	u.pH	7,28	8,5	7,37	7,62	6,8
CE	dS/m	11,4	1,027	10,7	1,353	11,38
ST	g/kg	16,5	291,4	13,6	156,8	26,1
SV	g/kg	11,3	266,6	8,5	122,3	19,3
Total N Kjedadhl	g/kg	2,31	6,2	1,95	4,7	2,61
Ammoniacal N	g/kg	1,55	3,1	1,38	1,8	1,7

## Drip irrigation



# Slurry treatment plants

## (Nitrification - Denitrification) Biological treatment

Nitrification-denitrification (NDN) is a process involving two groups of bacteria, nitrifying and denitrifying bacteria.

Each of them requires specific and differentiated conditions. When this process is carried out in a Sequencing Batch Reactor (SBR), the phases alternate between periods of aeration and periods of non-aeration in order to eliminate the initial nitrogen from the system in the form of nitrogen gas (N<sub>2</sub>).



Lindvall fume hood. Fume meter



N-DN cow farm



The nitrogen distribution values in the different flow lines are presented. The average value of nitrogen at the solids outlet is around 7%, although this value varies throughout the year. The emissions of unwanted gases (NH<sub>3</sub> and N<sub>2</sub>O) are only around 3.05%, while the amount of nitrogen leaving the reactor in the effluent represents 28.66% and in the sludge purges 2.14% of the initial nitrogen.

Overall, the average biological denitrification in the 4 spot studies carried out over the year gives an output of atmospheric nitrogen gas (N<sub>2</sub>) of 58.32% of the incoming nitrogen.

**Request complete study.**

**58.3% nitrogen reduction  
(in the form of N<sub>2</sub>)  
Consumption from 12 to 15 kW h/m<sup>3</sup>**



3000 mothers up to 20 kg

N-DN 2000 fattening pigs farm







## Microfiltration plant and N-DN

This plant can be composed of three sections:

- N-DN (explained page 12).
- Microfiltration (higher concentration of phosphorus and nitrogen in the solid fraction).
- Decanting channels or decanters. Decanting channels are designed for salt reduction. This process allows us a high reduction of nitrogen and phosphorus, concentrating in the solid fraction and a sufficiently clean liquid of solid particles that can be injected to drip irrigation.

With this system we achieve 85 to 90% less nitrogen in the liquid fraction.

The plant is designed to be installed in three phases depending on:

- Nitrogen reduction needs.
- Available land for application.
- Demand from the administration.

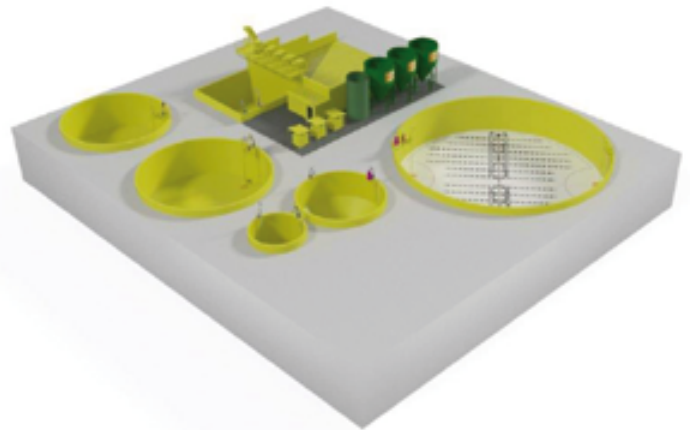

### What is the difference between NDN treatment and other slurry treatments?

*The NDN is the only system approved in the BAT, which transforms the nitrogen into N<sub>2</sub> and automatically releases 60% of the soil, in addition to the export of the solid fraction, which together can exceed 90%.*

### Nitrification pond



### Nitrification system



### Microfiltration separation



### Channel cleaning system





# Acidification systems

It encourages frequent emptying of the pits and avoids having to cover the pits, which is essential for the slurry to enter the evaporation tunnel.

The following conclusions can be drawn from the studies carried out:

Acidification of slurry reduces ammonia emissions at farm, storage facilities and in land application.

Frequent pH adjustment of slurry on pig farms reduces ammonia volatilization by 70%.

Ammonia losses during slurry storage are reduced by about 50% compared to untreated slurry stored with a natural crust.

Acidification of slurry reduces ammonia volatilization during and after field application.

CO<sub>2</sub> and H<sub>2</sub>S levels increase during acidification, but decrease during storage, so there is no significant difference if the whole process is taken into account.

Different studies show a decrease in methane production between 67 and 90%.



## What does acidification consist of?

Sulfuric acid is added to the slurry to lower its pH to 5.5, thereby increasing the ammonium concentration and reducing free ammonia emissions.

The addition is carried out in a dedicated tank, followed by homogenization.

The system is fully automated to avoid risks to operators or animals.

## Diagram of acidification plant

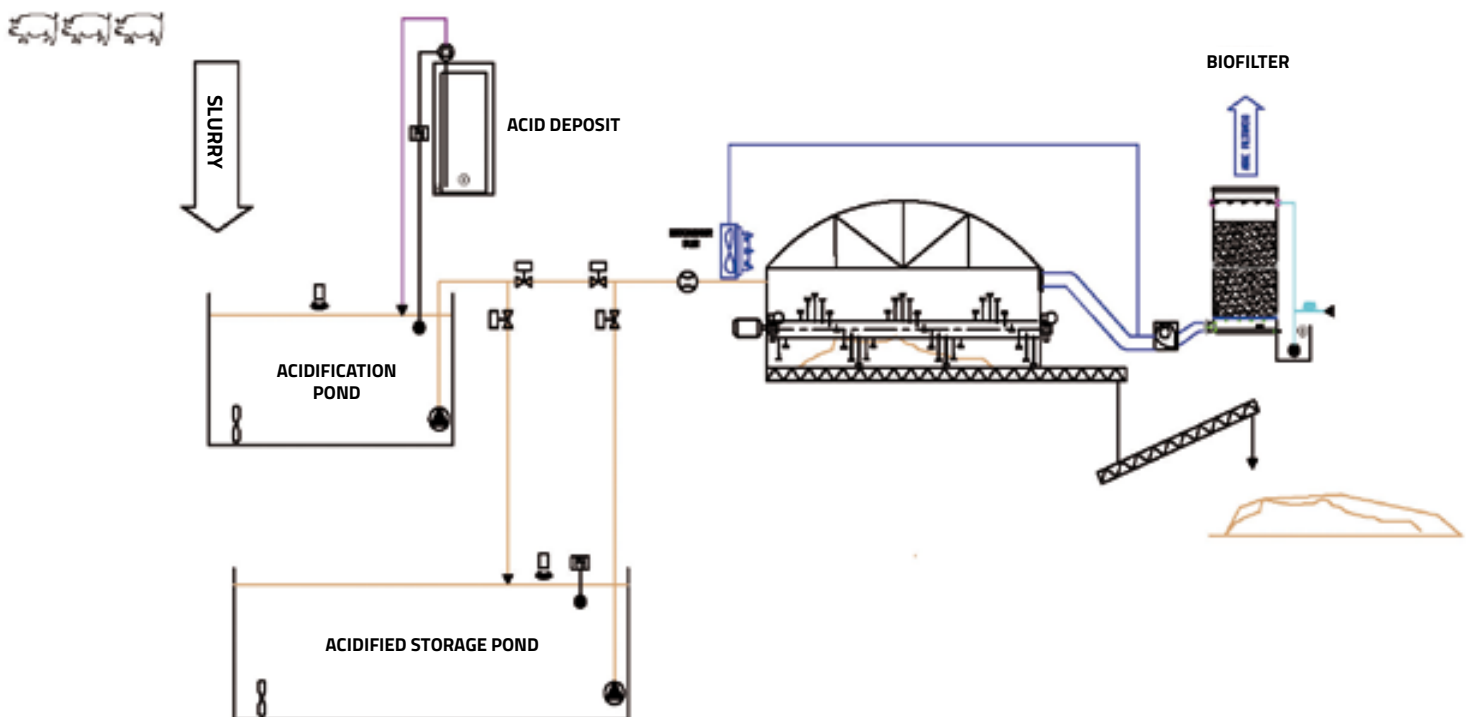

# Slurry evaporation tunnel

Let's take advantage of the solar wealth that the rest of Europe does not have, saving money and taking care of the environment.

## The solution to slurry, only with solar radiation

It consists of evaporating the liquid fraction contained in pig or cattle slurry by concentrating up to 90% of the nitrogen in the resulting solid fraction 10% of the initial volume.

System validated in MTD.

The system can be combined with other treatments to make nutrient distribution more efficient (flocculation, NDN sludge...).

We invite you to visit some of the installations already in operation.

## WHY USING EVAPORATION?

- By concentrating and not destroying the nutrients, it is useful for newly built farms.
- We can use the nutrients on our land and distribute the same kg of nitrogen in less than 50% of trips.
- By evaporating but keeping the nutrients in the solid fraction, the solid fraction has a high agronomic value.
- We avoid odors at the time of distribution, as the resulting fraction with more than 50% (between 50 and 80%) of dry matter no longer smells.
- The solid is considered as compost and is therefore easy to sell.
- We reduce ammonia emissions into the air by more than 90% due to acidification.
- The exhaust air from the tunnel passes through a bio-filter which avoids GHG emissions.
- The cost of treatment is very low, as the work is done by solar radiation.
- Nitrogen emissions by infiltration into the subsoil are the same as those of compost. Studies show that it practically does not pollute the water table.

## Slurry evaporation tunnel



No AMD CEE-773649-2

# Nutrient concentration in the solid fraction

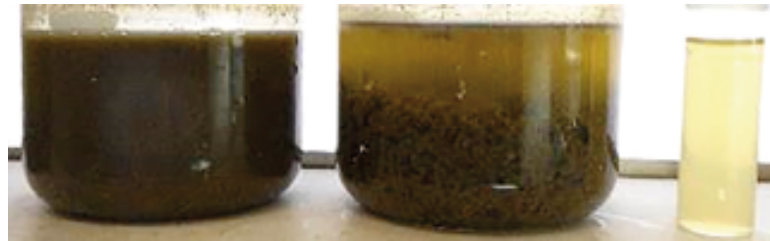

## Separation with flocculant

### OBJECTIVE

Having a greater reduction of nitrogen and phosphorus in the liquid fraction resulting from the separator or ramp separator.

With this treatment we will obtain two fractions: the liquid and the semi-liquid. The semi-liquid fraction (which will have approximately 11/14% of dry matter) will have approximately 35% of nitrogen and 80/85% of phosphorus.

The volume of this fraction compared to the input will be approximately 20%.

**Product result of a complete plant.**

It is always applied after a separation equipment, so there will be three products left on the farm:

- Solid fraction (separator outlet) 20/35% dry matter.
- Semi-liquid fraction (branch outlet with flocculant) 11/14% of dry matter.
- Liquid fraction.

## Separation equipment for working with flocculant

The separation equipment consists of a ramp with a sieve made of johnson mesh and special anti-flocculus brushes.

### INSTALLATION

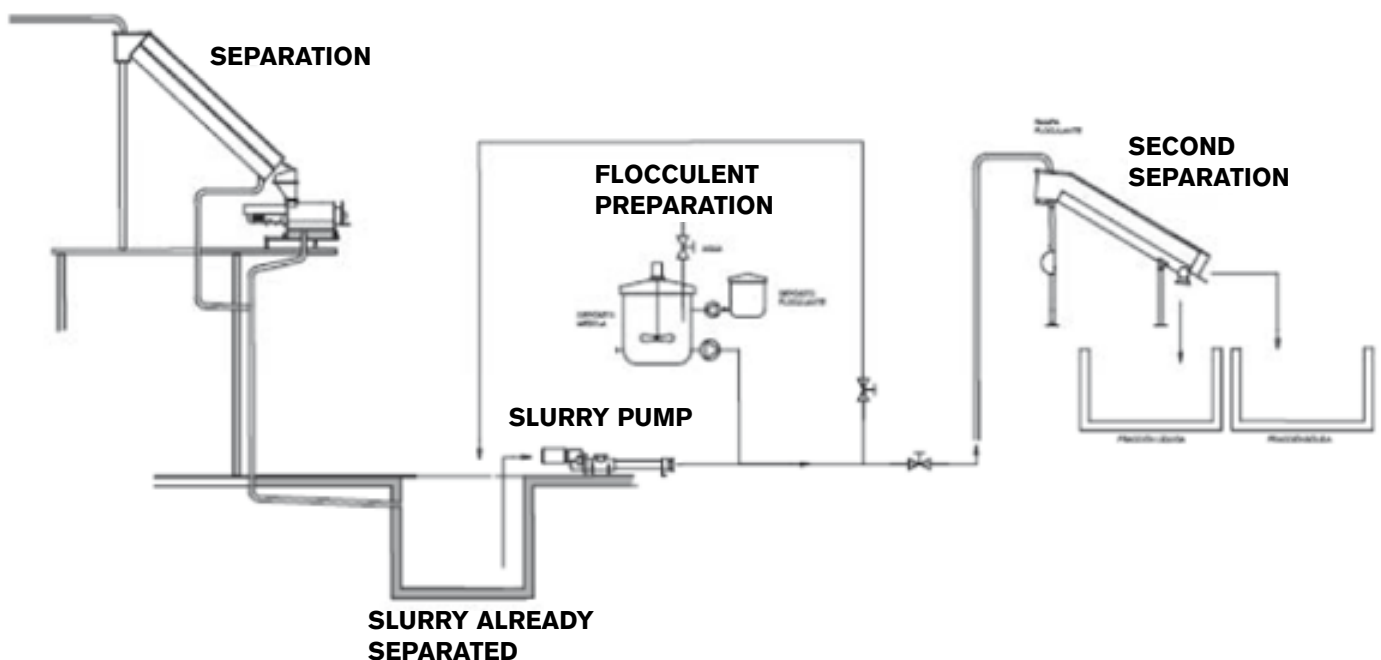





## Flotation plants

### Dissolved air flotation plant DAF

The main objective of the DAF technology is to separate the solid part of the effluent as much as possible.

The system is a physico-chemical treatment consisting of coagulation plus flocculation.

Coagulation is the separation of the solid particles from the liquid.

Flocculation is the union of these particles in order to create a floculus that has a hydration for flotation.

To achieve this flotation, we inject dissolved oxygen (micro bubbles) so that it floats to the surface, where it is evacuated to the sludge tank with the help of the dragging blades system.

They are made to measure, depending on the amount of slurry to be treated. Thanks to the action of the coagulant we manage to lower the pH and we can concentrate up to 70% of the nitrogen in the solid fraction.

Option: at the outlet of the solid fraction, we can put thickening agents to reduce this fraction. They can also be placed at the inlet to the evaporation tunnel without the need for acidification. At the inlet, if the slurry has more than 1.5% solids, use **Kompack 1**.



# AGV Sucker®

## Cleaning robot for pig farms



The objective of the Sucker is to continuously extract the slurry from the internal pits of pig farms, so that it can be taken to the external storage areas from where it can be treated and valorized on a daily basis, before it starts fermenting.

### Let's improve the image of our farms

The general population has perceived that slurry emissions are highly polluting and harmful to the health and well-being of living beings.

This can actually occur during the ageing process of the slurry, before it is treated or applied in the field. The decomposition of the slurry in storage involves microbial activity that produces and emits a large part of the polluting compounds that we want to avoid.

The working conditions inside the sheds make it unattractive for labour and the supply of qualified workers is reduced.

This is why we present a solution that not only improves our welfare and our image, but also improves the growth of the animals, saves energy by not having to ventilate so much and, of course, also improves our welfare.

Sucker is an AGV robot that includes a Hoover that absorbs liquid and solid slurry from pig farms and stores it in an internal tank.

Once it has filled the tank, it automatically moves to an evacuation point on the farm for emptying, if it is interested in entering the farm's treatment process. Once emptied, it returns to the point where it has stopped and continues cleaning.

To make the equipment more profitable, once the cleaning of the shed is finished, it automatically leaves the shed and goes through a cleaning and disinfection system so that the same equipment moves to the next one to carry out the same work.

The equipment is equipped with batteries that can be charged by connection to the mains or by solar energy. When the equipment detects that it has no charge, it automatically moves to the recharging point.

With this equipment we solve the RD 306/2020 of 11 February on the management of pig farms, as the emptying will be daily.







This graph shows the percentage contribution of ammonia emissions in each phase of a closed-cycle farm (contains all livestock phases).

It can be seen that the fattening phase produces the highest proportion of ammonia emissions. This is due to the storage of slurry in the inner pits of the houses, in the outer lagoon. Therefore, we understand that this is a law that is here to stay.

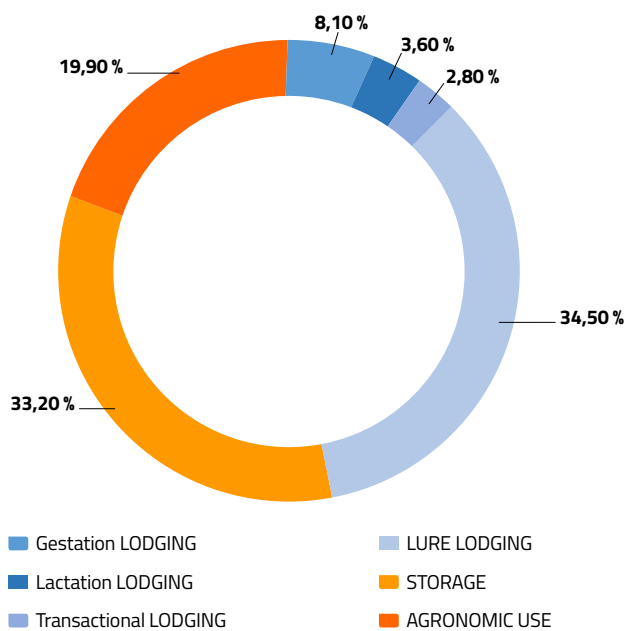

### A SOLUTION TO SLURRY AND THE WELFARE OF ANIMALS AND HUMANS

- Incorporate a new process on the farm, inside the sheds, which is where the slurry originates, to solve the existing problem with the storage of slurry in indoor pits, by extracting it daily.
- Improve the health and welfare of the animals and their caretakers.
- To avoid slurry fermentation.
- Improve the sustainability of pig farms:
  - Practically total reduction of indoor emissions.
  - Reducción Overall reduction of emissions to the outside world.
  - Reduced mortality and increased animal growth.
  - Reduction in water consumption for cleaning and energy consumption for forced ventilation.
- Improve efficiency and encourage the use of slurry treatment and recovery technologies, reducing the costs of the plant itself and of treatment.
- To promote the image of a quality, innovative and environmentally friendly industry.
- To obtain a competitive advantage in the sector at international level, where there is still no technology or procedure that effectively meets all the needs detected in existing farms.





# Biogas

## Stirrer support inside the digester

- Supporting mast for submersible stirrers installed inside the digesters, with lifting/lowering and lateral directional mechanism to be operated from the outside.
- Sealing mechanisms that allow the manoeuvre to be carried out with the digester in operation.



## Biogas digester hood

- The system allows access to the stirrer installed inside the digester without the need to empty the gas through the gas, through the chamber created inside the digester.
- It incorporates an internal viewing window.
- With support mast for submersible stirrers installed inside the digesters, with lifting/lowering mechanism and lateral directionality to be operated from the outside.

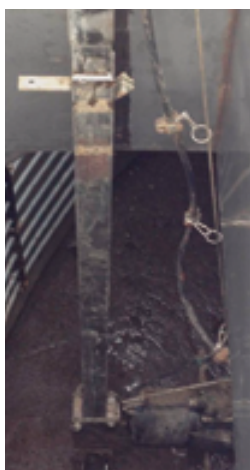

## Biogas receiving tank mixer

Stirrer-mixer specially designed for biogas plants. When solid material such as silage, manure solid material such as silage, manure, maize, etc. to the suspension, a very good mixing is necessary before pumping them into the biogas reactor.

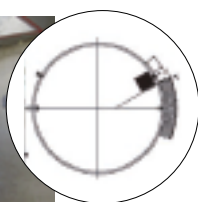
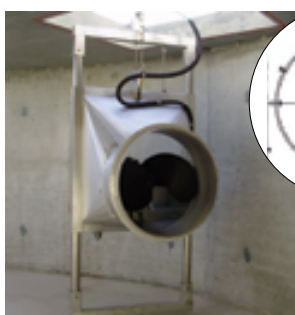

## Stone lock shields in pumped absorption circuits

Placed before the suction pump. Due to its design, it ensures that the stones are stored inside its cubicle, preventing them from damaging or clogging the pump. Through its external hatch, it facilitates the extraction of the stones. Made of stainless or galvanized steel. Connections to existing pipes.



## Separator buffer tank

Prepared to be installed in any model of separator and ideal for continuous digestate inlet circuits with low flow rates; this allows us to make the most of the separator's performance and prevent it from working with a low load. It incorporates maximum/minimum sensors.





**FREQUENT EMPTYING**

**WEEKLY EMPTYING  
OF SLURRY PITS**

## Airesa slurry trays

### Sustainability

**Airesa slurry trays are placed under the slats in all production phases of the farm, offer the possibility of weekly slurry evacuation and, in combination with the ventilation system, improve the welfare of the animals. They offer the possibility to evacuate the slurry weekly and, in combination with the ventilation system, improve the welfare of the animals.**

The chamber created between the bottom of the trays and the floor becomes a temperature regulating space. With a proper ventilation system, the sows breathe healthier air, which results in increased productivity.

- Increased feed intake (more than 10 kg / sow / cycle)\*.
- Lower mortality rate of suckling piglets (up to 0.6%)\*.
- Increased piglet growth (up to 0.6% kg / piglet)\*.
- Lower energy costs.



**Ventilation inlets lower cellar trays.**



**Delivery room before grids are put in place.**



**Central aisle with ventilation distribution to the rooms.**



**The free space underneath the trays allows all ducting and wiring to pass through.**





## Slurry for cow bedding

Separator model BENFORT - X25  
Specially for cattle

**Yes! The reuse of the solid fraction of the slurry generated by the farm itself to make the bedding in the cubicles or hot bedding is already a reality. This system saves a lot of money in the purchase of products such as sand, straw, calcium carbonate, etc...**

### HOW IT WORKS

First we will separate the slurry with BENFORT equipment, as this allows us to obtain around 30/35% of dry matter in the solid fraction. This solid fraction is then physically suitable for use in the animal bedding, either with or without prior sanitization (recommended: see next section).





## SISHICA sanitation system

Mecàniques Segalés has developed and patented an ideal sanitising process for cow farms.

They consist of an air injection pipe, fan, remote control GSM control panel and a practicable cover (optional).



### What is the purpose of the SISHICA sanitation system?

The objective is to raise the temperature to a thermophilic regime, reaching near or above 70°C and thus disinfect the solid fraction through an exothermic microbiological process.



## Conclusions of the study of the Mecàniques Segalés system: solid fraction of slurry for animal bedding

### Pile disinfection system in treatment

Moisture reductions greater than organic matter degradation. Good material dewatering system.

Very high levels of sanitisation: reductions of more than 90 and 99% of viables.

Reductions of viable faecal indicators (coliforms and E. coli) always clearly above 99%.

Reductions of viable enterobacteria and clostridia in the solid fraction always higher than 99%.

Increased sanitization in the piles without structuring. If required, it is much better to add the structuring, if it is already hygienically suitable, after hygienisation.



### SANITATION OF SOLID FRACTION OF CATTLE SLURRY

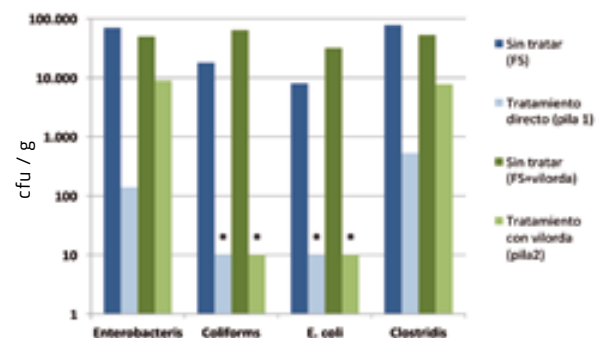

Decoding: bars with an \* represent results below the analytical detection limit and have to be interpreted as: < 10 cfu/g.

# Rack for beds

**Modelo: LIFE**

**COW BEDDING RACK**

**Power: 30 hp**

The rack is used to aerate and fluff the product placed in the bedding of the cow's cubicle. This rack is ideal for its design suitable for any type of cubicle and for its versatility of tines in terms of positions and heights that allows us to reach all the corners of the cubicles.

It is ideal for daily use. In this way, we favour the process of sanitising the life of bacteria and allow them to carry out their work of colonisation.

By removing the product daily, the comfort of the animals is superior, as it is spongy and not caked, the cow remains lying down for longer.

Its daily use provides a better quality of life for the cow, thanks to its comfort.



## WHY THIS RACK SYSTEM?

It is highly versatile. It is able to adapt to any cubicle thanks to its width and height adjustments.

It can work on both sides: left and right.

It has screwed couplings to be able to work independently in telescopic or tractor. With just one model, we can work it with the machine we are most interested in.

It includes 14 adjustable tines placed every 10 cm. These are replaceable, so if they wear out more on one side than the other, we can replace them and still have a new machine.

It has three independent tine height adjustments, depending on the cubicle: 9.5 cm - 13.5 cm - 17.5 cm. This way we can reach all points of the bed.

## TECHNICAL DETAILS:

**Working width:** 1,55 m

**Hydraulic drive required:**

1 double-acting element to be able to lift the rack at the end of the cubicles or on displacements.

# Bedding machine

**Modelos:**

**REST - 1 / REST - 1,7 / REST PLUS - 2,10**

## WHY THE BEDDING MACHINE REST?

The design of our sanitation system facilitates the loading of the sleeving machine and allows it to go directly to the cubicles for distribution.

It has an internal rotor that prevents the solids from caking in the hopper and allows us to distribute at a constant speed.

The output of the belt is adjustable. This allows the quantity of material to be adjusted at any time depending on the time of year and the condition of the cows.

Due to the low density of the solid material, a 60 HP tractor is sufficient to make the cubicles.

There are 3 models of bedding machine depending on whether it is installed on a tractor or telescopic.

The belt design allows unloading on both sides.



## TECHNICAL DETAILS:

- Three-point hitching to the tractor by means of a loader linkage or attachment to suspended telescopic shovels.
- Autonomous loading of materials.
- Possibility of the third point made to measure.
- Hydraulic hoses with anti-scratch protection for longer life.
- Protective nozzles for quick coupling during storage.

## NEEDS:

- Hydraulic drive required on the tractor: 2 elements, double acting.
- Hydraulic drive required at the tip of the shovel or telescopic handler: 1 double-acting element.

# Submersible mulcher pumps

## Submersible mulcher pumps

### ADVANTAGES:

- Very robust
- Crushing
- Corrosion resistant
- Flow regulation by means of variator or valve

### POINTS TO TAKE INTO ACCOUNT:

- Low manometric head
- Low power/pressure efficiency



## Submersible dirty water pumps

### ADVANTAGES:

- Corrosion resistant
- Good head
- Good power/pressure efficiency
- Flow regulation by means of variator or valve

### POINTS TO TAKE INTO ACCOUNT:

- No crushing but solids are allowed
- Not advisable for unseparated slurry



## Helicoidal surface pumps

### ADVANTAGES:

- Self-priming
- Good head
- Good power/pressure efficiency

### POINTS TO TAKE INTO ACCOUNT:

- Regulation only by variator (no tap)
- Somewhat delicate
- No shredding but can handle solids
- Cannot run dry
- Low power/flow efficiency

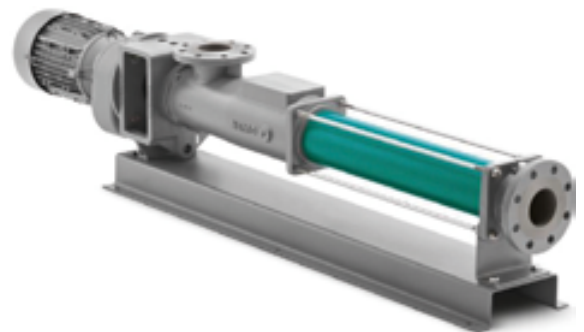

## Self-priming pump with mobile trolley

- The pumping equipment is mounted on a trolley which gives us access to doors and corridors inside the farm. In this way, we can reach the most difficult pits to extract the slurry.
- The trolley incorporates a 100 diameter hose, which just by introducing it into the pit sucks up the slurry.
- We have different models depending on the m<sup>3</sup> we want to transport, distances and heights.
- It incorporates an electrical panel with all the safety features required by the European Community.



**MODEL S85: 5,5 kW, ELECTRIC PANEL.**  
**APPROXIMATE DETAILS: \*ASPIRATION: 0/-5 m**  
**\*DISCHARGE: +12/+5 m - \*FLOW RATE: 50/15 m<sup>3</sup>/**



# Interior homogenization



## SI95 Pig stirrer

Designed for pig slurry, to agitate the pits without having to lift the grids off the ground. Made entirely of stainless steel.

Its design makes it easy to transport and allows access to the most difficult places.

- **Adjustable in height.** The layers of solid slurry are not always at the same height nor are all the pits the same size, so it incorporates a winch with a brake to make the work more practical and safe.
- **Openfast paddles.** The power of the engine is transmitted with maximum effectiveness to the *openfast* paddles which, due to their inclination, size and shape, maximize the power.
- **Side protection.** The shaft and paddle protection system makes agitation easy and safe, as it prevents the paddles from hitting the base and sides of the pits.
- **Safety connection.** Avoids accidents and with quick connection.
- **Energy efficient.** A great improvement in the motor that reduces energy consumption.
- **Easy handling.** The four wheels (front wheels smaller than rear wheels) make manoeuvring and moving easier.



Grid space greater than 18 mm

## SI95X Pig stirrer



Grid space greater than 18 mm

Prepared to churn the pits without having to lift the grids off the ground, facilitating the emptying of the slurry. Incorporates a tilting folding propeller system. Anchoring system at different degrees for better agitation.

- **Height adjustable.** The layers of solid slurry are not always at the same height, nor are all the pits the same size, so it incorporates a winch with a brake to make the work more practical and safe.
- **Openfast paddles.** The power of the engine is transmitted with maximum effectiveness to the *openfast* paddles which, due to their degrees of inclination, measurements and shape, manage to maximise the power.
- **Side protection.** The shaft and paddle protection system makes agitation easy and safe, as it prevents the paddles from hitting the base and sides of the pits.
- **Ergonomic.** Due to its wheel system, dimensions and support, it is easy to move around the farm, even over uneven ground.
- **Incorporates water injection.** When the solid layer of slurry does not have enough liquid to be mixed, the SX stirrer incorporates a direct water injection system to the paddles to obtain maximum performance.
- **Multidirectional.** The slinger system allows to agitate in five different fixed positions or to move it freely both horizontally and laterally in the pit.

## KI125X Cow stirrer

Prepared to churn the pits without having to lift the grids off the ground, facilitating the emptying of the slurry.

Incorporates a tilting folding propeller system.

Anchoring system at different degrees for better agitation.

- The ergonomic design allows easy and comfortable work.
- Incorporates lower propeller protection.
- Three-phase motor at 230 or 400 V.
- Self-lubricating central and lower bearing.
- Electrical panel for connections.



Grid space greater than 30 mm

# Mobile long reach mixers for indoor/outdoor pits

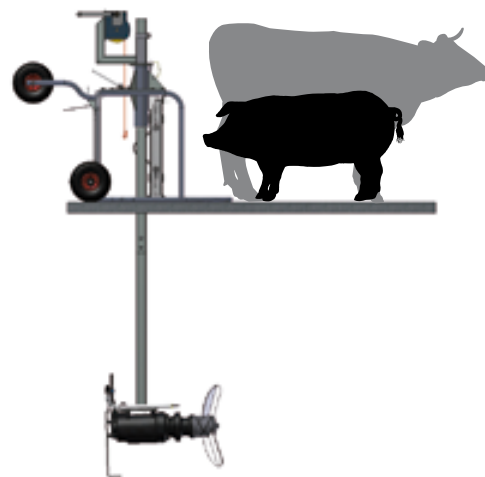

## FER Pit Stirrer

Submersible stirrer designed to stir small or medium-sized pits and with minimum heights of 50 cm and maximum heights of up to 4 m, by means of a mast that allows the necessary height to be adjusted at each moment of stirring.

- Directional mast for shaking at different angles; in this way, by placing it in the centre, it is possible to shake on both sides.
- 70 cm wide, to be able to pass through the access doors to the sheds.
- Removable lifting mast for easy access to the inside of the covered installations.
- Mounted on a mobile trolley for easy movement around the farm and placement in the pit.
- Puncture-proof pneumatic wheels.
- Safety anchorage.
- Integrated electrical panel.

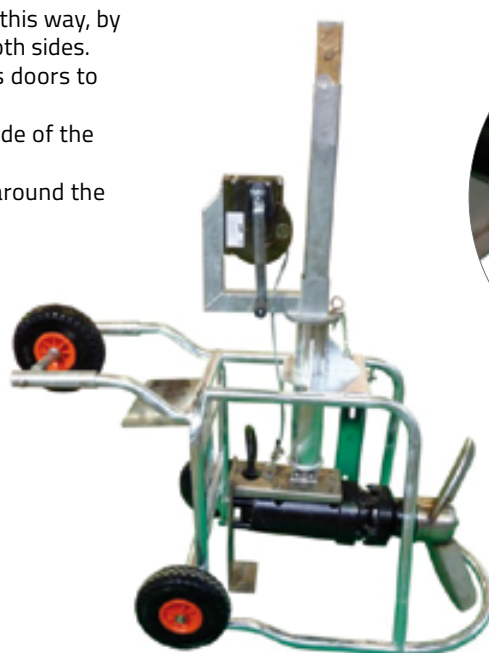

MIXER IN  
INTERIOR PIT

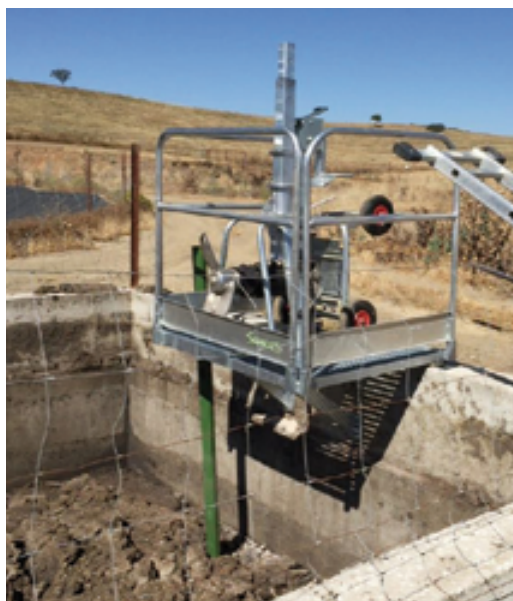

OPTION TO USE IN EXTERNAL PITS  
EXTERNAL WITH SUPPORT PLATFORM



# Hydraulic stirrer

Specially designed to solve problems of solids accumulation in the external and internal ponds of pig and cattle farms as well as biogas plants.

Ideal for homogenizing the slurry and thus being able to remove the maximum amount of nutrients from the ponds, from the first tank to the last.

By agitating the slurry, the depressor in the tanks does not need to use as much force to load the slurry, and thus we achieve a longer service life..

## Why using a hydraulic stirrer?

Pue to its characteristics, it can be connected to a hydraulic power unit with an electric motor or to any machine (tractor, manitou, etc.) with a hydraulic connection. This allows us to ensure safe operation.

Possibility of placing it with a mast on a raft wall. By working horizontally, we match the performance of the electric ones with the advantage of being able to place them in different points.

## Which stirrer best suits my needs?

To decide which one is the best, several points must be taken into account:

- Percentage of solids to be moved
- Length and width of the basin
- Shape of the basin
- Final objective of the slurry

Our technician will advise you on which one is the best according to your objectives.



As it is not attached with a mast to a tractor or machine, we avoid possible accidents such as falling into the basin, as thanks to its hoses, in the event of any accident, it would not drag the tractor into the basin.

It is safe to work with biogas as there is no source of ignition in an explosive area.

With only one hydraulic power unit, we can drive different stirrers.

The hydraulic unit must be cooled.

## DIVA

MODELS:  
50 / 60 / 70



## TECHNICAL DETAILS

MIN. REQUIREMENTS 50: 60 litres and 160 bars  
MIN. REQUIREMENTS 60: 90 litres and 180 bars  
MIN. REQUIREMENTS 70: 110 litres and 280 bars

# Stirring

## Electric stirrer for livestock

Due to the design of its two large-area blades, it generates a current that is especially suitable for long-distance basins or for more than 8% solids.

Submersible mixer from 2.2 to 18.5 kW, characterized by high quality, flexibility and safety.

- Submersible mixer from 2.2 to 18.5 kW, characterized by high quality, flexibility and safety.
- It incorporates temperature and leakage sensors for a long service life.
- The design and size of the propellers are able to descale the solids deposited on the bottom and floating solids. In this way, the basins can be completely emptied.
- The mechanical seal is well suited for even the most difficult removal tasks.
- Equipped with planetary gearbox for maximum power.
- Optionally available with explosion-proof certificate.



## BLADE DIAMETER DEPENDING ON POWER

P KW	2,2	3,0	4,0	5,5	7,5	11,0	15,0	18,5
Ø mm	550	540	550	600	650	800	850	870
N*m/s	2.200	3.000	4.000	5.500	7.500	11.000	15.000	18.500



## Tripal Stirrers

**Three-blade stirrers are ideal for working with many solids. Although they have less speed than the two-bladed ones, they exert much more current force, which is the one that wears.**

In this type of basin the important thing is the force we exert to lift the solids that have settled to the bottom of the basin with the minimum possible consumption.

The different size of the paddle diameter and the electrical power are the ones that define the newtons needed for each size of basin and the percentage of solids to be moved.

They are especially suitable for slurry reception basins.



## Electric stirrer with external motor

**Specially designed to be placed in ponds full of slurry or with a canvas floor, it allows us to solve the problems of accumulation of solids at the bottom without any construction inside the pond.**

From the outside we can change its agitation height, as well as its direction.

The propellers have three blades, achieving a great agitation force.

This equipment can also be installed with the biogas entering from the side of the digester. The advantage is that the maintenance of the equipment is done from outside the digester without having to empty the methane from the dome.



## TXR external tractor mixer

**Submerged part without bearings. Incorporates friction bushing with the latest generation of corrosion-resistant material.**

**Different propellers depending on the access and the type of slurry to be churned.**

- Manufactured on reinforced chassis and fully hot dipped galvanized.
- Equipped with hydraulic tilting cylinder or manual spindle.
- Double anchoring system for different ball diameters.
- Foldable support brackets.



# Fixing systems for stirrers

## Fixing systems for stirrers

- Made of hot-dip galvanized steel or stainless steel.
- Directional supports that allow the angle of agitation to be varied.
- Lifter with non-return device.
- Built-in safety chain.
- Adaptable to all models.
- Incorporate safety elements for the user.
- Adaptable to all types of basins, tanks or reservoirs: cement, sheet metal, canvas, covered, overhead, etc.



**OPTIONAL ELECTRIC WINCH**



**SUPPORT FOR SLOPE RAFTS WITH INTERNAL SUPPORT**  
For newly constructed basins, with concrete or PVC slope



**SUPPORT FOR SUSPENDED PVC SLOPE BASINS**  
For raft with tarpaulin slope



**OVERHEAD SUPPORT FOR ELEVATED TANK**  
That does not allow support on walls



**"JET" WHEELED SUPPORT FOR RAFTS WITH SLOPES**  
For sliding on rafts with concrete or PVC slope



**SUPPORT FOR OPEN VERTICAL WALL TANKS**  
For open concrete tank



## AGITATOR SUPPORT FOR RAFTS COVERED WITH TARPAULIN

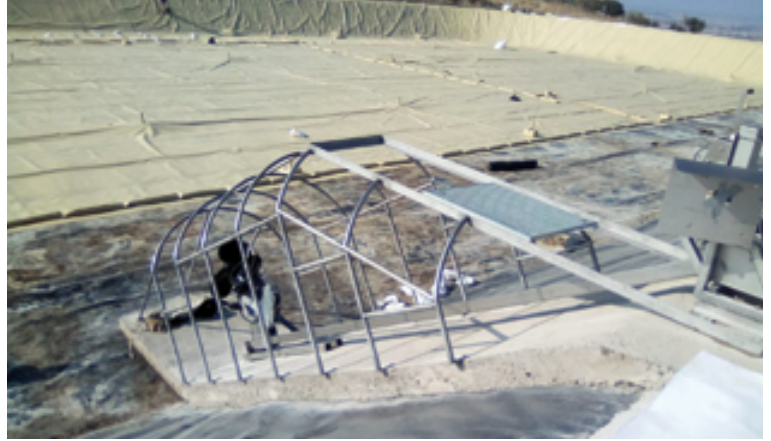

# Slurry loading and volume and nitrogen controls

## Vacuum tank filler tube

Slurry extraction pipe. Prepared to connect to the tank with quick coupling. It incorporates a closing guillotine and an unblocking valve.

Facilitates the emptying of the pond, as the slurry is extracted from the base of the pond.

Made to measure for any type of tank

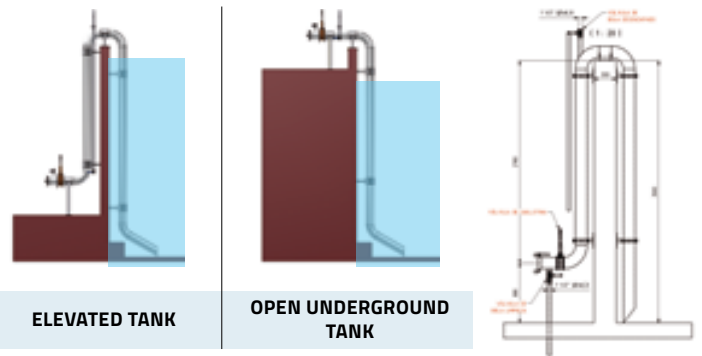

Also for tanks with slopes

## Volume and nitrogen meter

To control the volume of slurry extracted as well as the concentration of nitrogen in the slurry.

Registration of the truck's number plate.

Possibility of downloading the load history via SD card or by remote access via web.

- Equipped with quick-lock flanges.
- Touch screen with display of volume and loaded nitrogen.
- Conductivity meter.
- Stainless steel piping.

## Comfortable loading cone

Specially designed for loading automatic arm buckets.

Allows the tank arm to be attached without the need to get off the truck or tractor. Can be coupled to the Vacuum tube. In raised tanks, automatic air intake and cutter closure.





# Liquid filtration / initial roughing

## FICA channel filter

Designed for slurry treatment plants to be installed in the slurry reception area for roughing out large solids (bags, gloves, wood, etc.). It works through a curved screen and rotating blades that extract the solids from the screen to the outside.

- Perforated sheet metal sieve (optional triangular or handrail profile).
- Nylon or rubber brushes, depending on the product.
- Robust construction, AISI-304 body.
- Possibility of adapting auger or belt to remove solids.
- Sieve widths to suit the channel.
- Optional protective cover.
- From one to four cleaning arms.

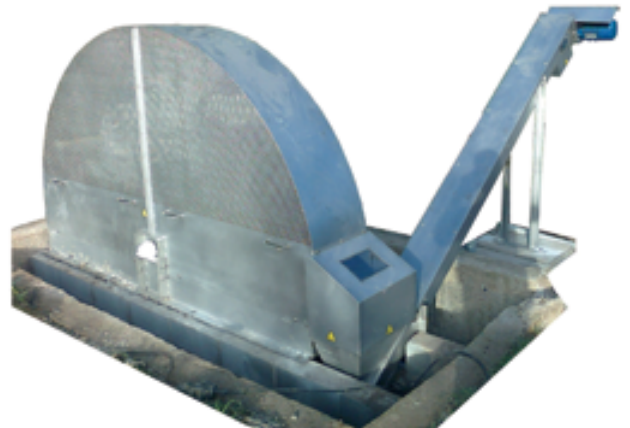

## Rotofilter or rotary sieve

Ideal for a second roughing. Once the solid fraction has been separated from the liquid, it is passed through the sieve to increase the degree of cleanliness of the liquid.

Especially used in large farms with 500 micron separators to reduce to 250 microns with minimum consumption.

Johnson type triangular mesh screen, which extends the life of the screen.

Easy access to the inside of the drum for better maintenance.  
Automatic cleaning option using water or brushes.  
Different sizes depending on the m3 to be separated and the size of the sieve.

MESH LIGHT / MODEL	FLOW RATES (m <sup>3</sup> /h)			
	0,25	0,50	0,75	1
RFT-300	30	52	70	76
RFT-600	65	110	145	160
RFT-900	90	160	213	230
RFT-1500	135	240	320	345
RFT-2000	185	325	430	470

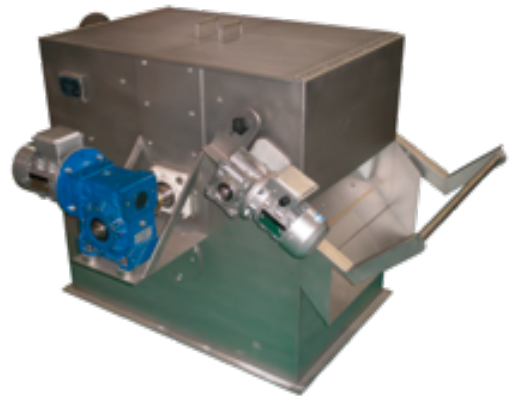

## Static ramps

### FIES Static Filter

**Ideal for filtering and reusing parlour cleaning fluid.**

**It offers an economical solution with no maintenance and no energy input.**

- Designed to recover liquids with very few solids (applications in waste water, tanneries, industrial processes, zootechnics...); in livestock farming, widely used for roughing or cleaning the liquid in the milking parlour.
- Easy to install. No electricity consumption, separates by gravity.
- Screening from 0.5 to 2 mm (triangular rod sieve). The inclination of the sieve ensures good filtration. Adaptable according to flow rate.
- Stainless steel construction.

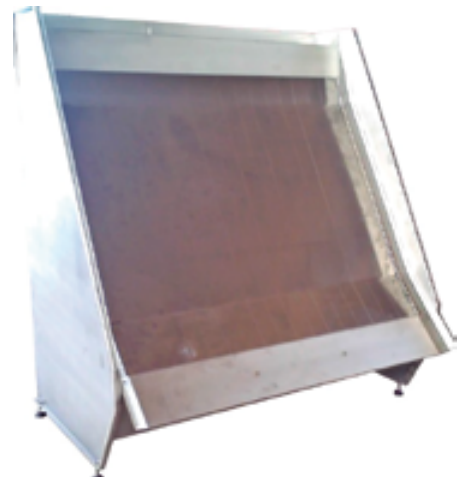

# Filtration of liquids / fine screening

## FILVI Vibrating Screen

Designed to separate the solid fraction from the liquid fraction up to 80 microns.

- Especially suitable for slurry once it has been roughed up. It incorporates an **internal cleaning system** through mobile elements that prevent solid particles from clogging the screen.
- Specially designed mesh clamping and tensioning system for easy replacement.
- Possibility of changing the mesh size at any time to achieve different screenings.
- Possibility of incorporating up to **three sieving levels**.
- Made entirely of **AISI 304 stainless steel** (standard equipment).



AUTOMATIC SELF-CLEANING SYSTEM

- Feeding via pump.
- Slurry settling tank.
- Possibility of inlet at the bottom to facilitate installation and overflow at the top.
- Manual internal regulator to adjust the flow rate to ensure constant feed to the vibrating body.
- Easily removable covers for proper cleaning.

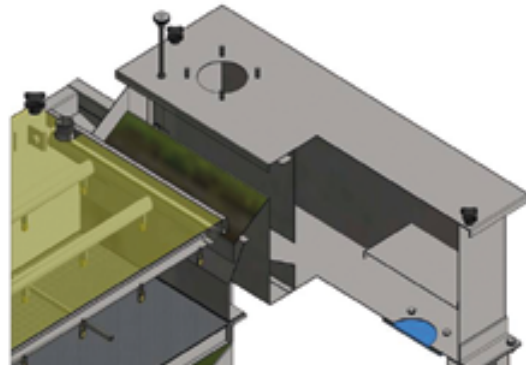

- The supporting structure and the body are made entirely of AISI304 steel, which is ideal for working with slurry.
- The vibrating body and the fixed structure of the chassis are isolated by means of 6 elastic dampers which have the function of not transferring the vibration to the structure.
- The mesh base is reinforced with perforated plate on the inside.



- Specially designed sieve clamping system for easy replacement.
- Possibility to change the sieve mesh at any time to achieve different screenings: 60, 80, 100, 120 microns.

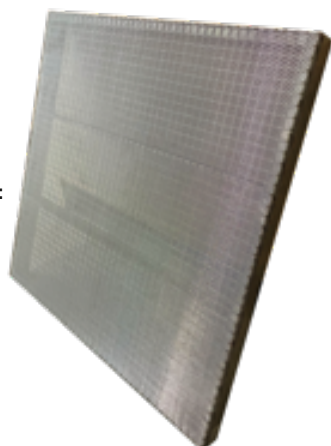

Driven by two **0.30 kW vibrator motors at 1500 rpm.**



# Types of control

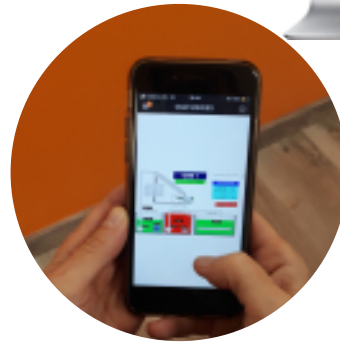

## Control panel (PTP)

- Level of the basins.
- Remote stop/start function of the installation.
- Sending alarms via SMS to mobile phone.
- Synoptic diagram display.
- Pond level graphs.
- History of all parameters: levels, flow rates, nitrogen, tank loads...
- Visualisation of all the installations on a map.



## Control Panel (PTPX)

- Allows the technical service to connect telematically to the equipment to resolve incidents and/or make system updates.
- Viewing the level of the tanks in real time from a PC.
- Remote stop/start function for each motor from a PC.
- Sending alarms via SMS to mobile phone.
- Visualisation of synoptic diagram.
- Pond level graphs from PC and mobile phone.
- History of all parameters from PC and mobile phone: levels, flow rates, nitrogen, tank loads...
- Visualisation of all the installations on a map from PC and mobile.

## Clean diffuse

Especially for the cleaning of diffusers in nitrification-denitrification plants.





# Accessories

## Flushing cleaning system

Cleaning system for cattle farms that allows reuse of the wash water after passing through a separation system.

- Great water savings.
- Minimum energy consumption.
- Incorporates reserve tank for possible emergencies.
- Fully automatic operation with valves and programmed control.

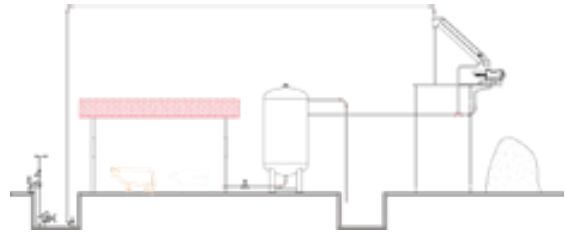

## Auger conveyors



- Closed, tubular or open screw conveyors with cover.
- Possibility of light or heavy spiral.
- Different thread pitches for different products.

## Open augers



- Auger open at the bottom.
- Ideal to achieve a homogeneous distribution of the product along the warehouse or evacuation box.
- Made of carbon steel or stainless steel.
- Possibility of adapting to a mobile structure.



## Electric winch to adapt to stirrers and pumps

Adaptable to any Segalés pump and stirrer support system.

Facilitates the movement and maintenance of the same.



**Mecàniques Segalés SL**  
C/ Savassona, 17  
08503 Gurb (España)  
T. +34 93 886 23 66  
comercial@segales.net

*Distributed by:*

 **Segalés**

**SLURRY SEPARATION,  
HANDLING AND TREATMENT  
SPECIALISTS**

**[www.segales.net](http://www.segales.net)**